

 **BRITA**

ON TAP
ON TAP P 

Instructions for use
Instrucciones de uso
Instruções de utilização
Manuale d'uso
Mode d'emploi
Gebrauchsanleitung
Gebruiksaanwijzing
Instrukcja obsługi
使用說明
简体中文



ON TAP

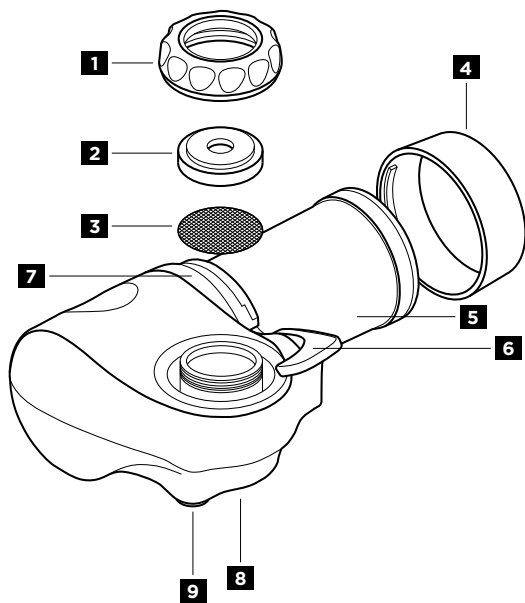

ON TAP P \boxtimes

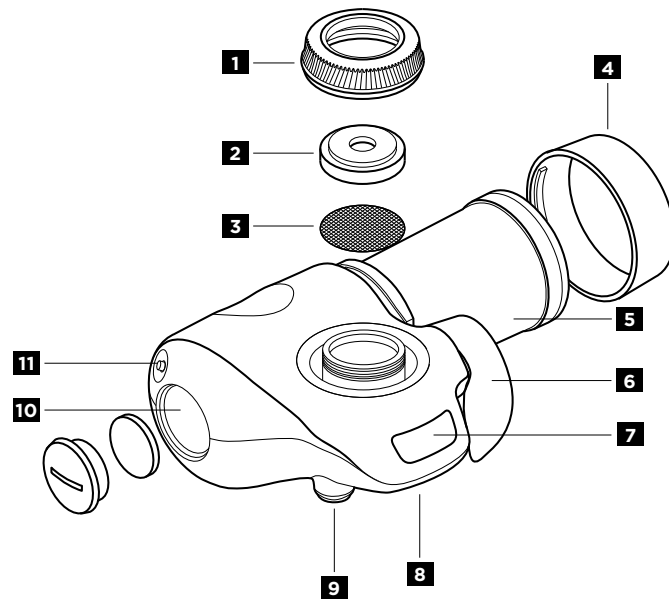

12

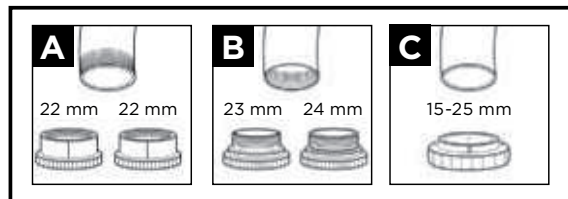

BRITA RITA

ON TAP

- 1 Attachment nut
- 2 Rubber gasket
- 3 Pre-filter screen
- 4 Filter cartridge cap
- 5 Filter cartridge
- 6 Water selection lever
- 7 Filter exchange indicator
- 8 Unfiltered water outlet
- 9 Filtered water outlet
- 10 Battery slot
- 11 Reset button
- 12 Optional adapters - Type A,B,C

BRITA ON TAP

	4-step filtration	5-step filtration
T	✓	✓
H	✓	✓
P	✓	✓
S	✓	✓
H	✓	✓
S > 60 µm	> 60 µm	> 0,5 µm
P 99,99%	✗	99,99%
L	✗	✗

ON TAP

For over 50 years, BRITA has stood for constant innovation and the highest quality of water filter solutions. To reach high quality requirements at BRITA there are stringent internal and external quality controls.

ON TAP

ON TAP water filter lifespan depends on local water quality. The ON TAP water filter filters up to 600 litres. To ensure optimum performance you should change your ON TAP water filter every 600 L / four months. To remind you of the next water filter change, your BRITA ON TAP is equipped with a filter exchange indicator.

ON TAP

To ensure that you get the best results from your BRITA ON TAP, please follow the instructions carefully.

ON TAP

This device can only attach to taps with a diameter between 15 mm and 25 mm. Before attaching the device to the tap, the matching adapter should be selected first. The adapters allow this device to be attached to most taps, except for:

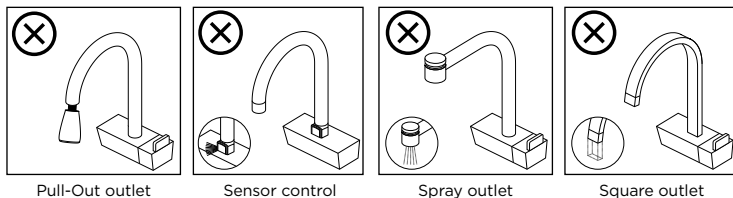
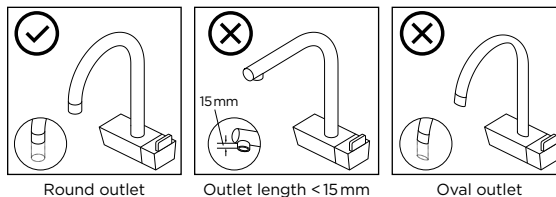

A. LCD Display

On the left side of the BRITA On Tap water filter system there is a battery slot, which can be opened with a coin or other flat object. Before first use, please remove the sticker from the battery and place the battery back into the battery slot. Press the reset button and the display countdown will start to work.

WARNING



**THIS PRODUCT CONTAINS
BUTTON/COIN CELL BATTERIES**

Button/coin cell batteries are hazardous and must be kept out of reach of children at all times, whether the battery is new or used. These batteries can cause severe or fatal injuries in 2 hours or less if swallowed or placed inside any part of the body. If it is suspected a button/coin cell battery has been swallowed or placed inside any part of the body, get medical help immediately. If the person does not appear to be seriously ill, call NHS 111 for advice. If they are showing signs of being seriously ill, such as being sick, loss of consciousness, drowsiness or seizures, call 999 to request an ambulance or take the person to your local A&E department.

I. Installation

Based on different adapters, please refer to different installation method.

A. Adapter A

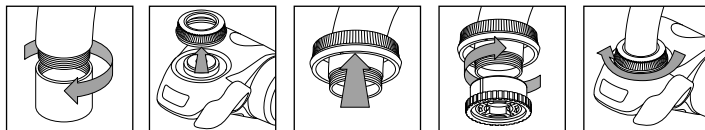

A. Adapter B

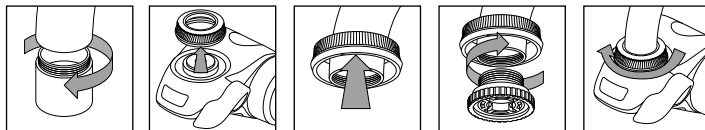

A. Adapter C

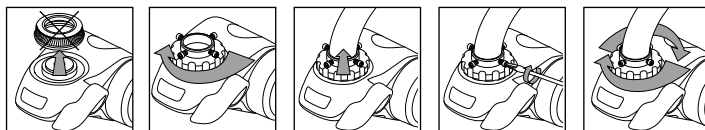

J. Filter Cartridge

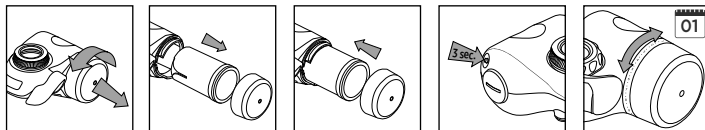

C. If the BRITA On Tap is new, the filter cartridge may still contain material residue. This is harmless to health and does not affect the performance of your water filter. Run water through the filter for 1 to 2 minutes to remove any residue. Please repeat this process with every new filter cartridge. You may use this water for your plants or it can be discarded.

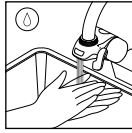
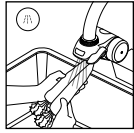
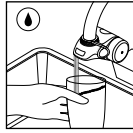

C Always use cold water (5 - 23 °C) for the filtered mode. Otherwise, the filter will be damaged.

C

For maintenance, remove the whole system from the tap in the reverse order of installation. Cleaning is recommended when the cartridge is replaced.

- Rinse the system body with unfiltered tap water. Do not use detergent, thinner or alcohol to clean the surface of the system body. Clean the outside of the BRITA On Tap with a damp sponge and mild washing-up liquid. Abrasive cleaners, detergents or chrome polish may mark the finish.
- Use a clean toothbrush to clean the unfiltered water outlet, and rinse off any contamination under running tap water and wipe well with a clean cloth.
- Do not put the BRITA On Tap or any of its parts in the dishwasher

U

For everyday usage: extract unfiltered water for 5 seconds before switching to filtered water mode to prevent filter from being clogged, and extract filtered water for 5 seconds before usage. If the BRITA On Tap has not been used for more than 2 days, repeat the steps for everyday usage but extract filtered water for 20 seconds instead of 5 before usage. If the BRITA On Tap has not been used for more than 2 days, repeat the steps for everyday usage but extract filtered water for 3 minutes instead of 5 before usage. If there is odour found in the filtered water, please change the filter cartridge.

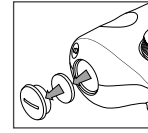
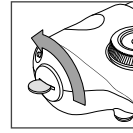
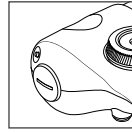

T

If a fault occurs, please read the following potential causes and their remedies. If the problem persists, contact your local BRITA customer service team.

Problem: I cannot attach the system to my tap.

Solution: Determine which adapter you need (see page 4). If the adapter does not fit, please contact your local BRITA customer service team.

Problem: Filtered water drips out of the water outlet even when the tap is turned off.

Solution: There is still water under pressure in the On Tap housing when the tap is turned off. It is normal for the filtered water flow to continue for a few seconds.

Problem: Hot water was accidentally run through the filter for a short time.

Solution: A small amount of hot water running through the water filter will not damage it. However, make sure you always use cold water for the filtering process.

Problem: Water leaks from the connection between the system and the tap.

Solution: A) Make sure you have chosen the right adapter for your kind of tap.
B) Ensure that you have attached the system to the tap correctly (do not use any tools!).

Problem: Water leaks from the side of the filter cartridge cap.

Solution: Ensure that the filter cartridge cap has been tightened properly.

Problem: The display countdown does not show anything when the water filter switch is in the filtering position.

Solution: A) Ensure that the battery has been installed correctly.
B) The battery is exhausted. See the section Changing the CR 2032 battery.



- BRITA filtered water is dedicated for human consumption only. It is a perishable food and as such please consume it within one day.
- Do not install the BRITA ON TAP on a water supply line with a water pressure exceeding 0.35 MPa. If the inlet water pressure exceeds 0.35 MPa, a relief valve must be installed (purchased separately)
- Do not install the BRITA ON TAP on a water supply line with a water pressure lower 0.07 MPa. If the inlet water pressure is lower 0.07 MPa, a constant water flow can't be guaranteed.
- The water temperature for the filtered water mode should be between 5 - 23 °C.
- Nominal flow: 1.6L /minute (according to JIS S 3201:2004)
- This device is intended for domestic use only.



BRITA ON TAP is designed for use only with municipally treated tap water (note: this water is constantly controlled and according to legal regulations safe to drink) or with water from private supplies which has been tested as safe to drink. If an instruction is received from the authorities that mains water must be boiled, then BRITA filtered water must also be boiled. When the instruction to boil water is no longer in force, the entire BRITA ON TAP must be thoroughly cleaned and a new water filter cartridge inserted.

For certain groups of people (e.g. those with impaired immunity and for babies), it is generally recommended that tap water should be boiled; this also applies to BRITA filtered water.



Like each natural product, the consistency of the BRITA Micro Carbon Pearls is subject to natural variances. This can lead to a slight abrasion of small carbon particles into your filtered water, noticeable as black bits. These particles have no negative health effects. If ingested, they will not harm the human body. In case you observe carbon particles, BRITA recommends to flush the water filter several times or until the black bits disappear.



At the end of the lifetime of the BRITA On Tap water filter system, please remember that it must be disposed of according to the local applicable regulations and statutory requirements as electric/electronic waste. Please remove the filter cartridge before disposal of the system and dispose it in normal domestic waste. The product contains a Lithium battery which must be disposed separately according to the local applicable regulations and statutory requirements.

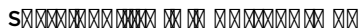

To prolong the life of our products we are happy to offer selected spare parts. Please reach out to your BRITA customer service or local distributor for information on availability.



Please understand that BRITA cannot accept any liability on their part if you do not follow the given usage instructions.

AE 4Homes FZCO
Gold & Diamond Park, Building 4, Office 133,
PO Box 61379, Dubai UAE
+971 4 3807611

BE/NL
BRITA SE
Heinz-Hankammer-Str. 1
D-65232 Taunusstein
Tel.: 0031 40 2818082
Tel.: 00800 14789632

CN BRITA China Co., Ltd
Suite 01-02 & 05-08, 8th Floor, Tower Two, Century Link,
1196 Century Avenue, China (Shanghai) Pilot Free Trade Zone
Tel: +86 21 6898 0200
Hotline: 400 9218 318

DE BRITA SE
Heinz-Hankammer-Str. 1
D-65232 Taunusstein
Verbraucherservice: Tel.: 0800 500 19 19

ES BRITA Iberia S.L.U.
Carrer de Valencia, 307, 2º 4ª,
08009- Barcelona
Tel.: 900 802 842
Fax: 0034 93 3427571

FR BRITA France S.A.R.L.
52 Boulevard de l'Yerres
91030 EVRY Cedex France
N°AZUR* : 0810 73 15 45
*Prix d'un appel local
(Lun-Ven de 10h à 13h)

HKSAR/PRC
BRITA Hong Kong Limited. Unit C, 31/F,
Tower A, Billion Centre, 1, Wang Kwong Road,
Kowloon Bay, Kowloon, Hong Kong, China
Tel: +852 3700 6088

IE Bluestone Sales and Distribution Ltd.
26 Oaktree Business Park, Trim, Co. Meath, C15 HK40, Ireland
+ 353 (0) 469483100
+ 353 (0)46 9483663

IT BRITA ITALIA S.r.l,
Via Zanica, 19K,
I-24050 Grassobbio (BG)
Tel: +39 035 203 447
Numero Verde: 800 913 716
Fax: +39 035 199 62 232

NG/KE
SUPERB LUXURY PRODUCTS LIMITED,
9th Floor, St. Nicholas House,
26 Catholic Mission Street, Lagos, Nigeria
+972-52-6162228

OM FMCG MUSCAT LLC
P.O. BOX 901, PC 114 JIBROO, OMAN

PL BRITA Polska Sp. z o.o.
Ołtarzew, ul. Domaniewska 6,
05-850 Ożarów Mazowiecki, Polska
Tel.: +48 22 721 24 40
Faks: +48 22 721 24 49

PT BRITA Iberia S.L.U.
Carrer de Valencia, 307, 2º 4ª,
08009- Barcelona
Tel.: 902 112 123
Fax: 0034 93 3427571

UK BRITA Water Filter Systems Ltd.
BRITA House, 9 Granville Way, Bicester,
Oxfordshire, OX26 4JT, UK
BRITACare: 0344 7424800

VA Aperture Importer Trading CC
Unit 6, Meadowbrooke Estate, Jacaranda Avenue, Olivedale,
Randburg 2185 Gauteng
(00 27) 082 569 8389
(00 27) 011 462 2605
(00 27) 011 462 2649